

BEDU
≡ POMPEN ≡

**REGENERATIVE SIDE CHANNEL
MULTISTAGE METALLIC MAG-DRIVE PUMPS**

SC MAG-M

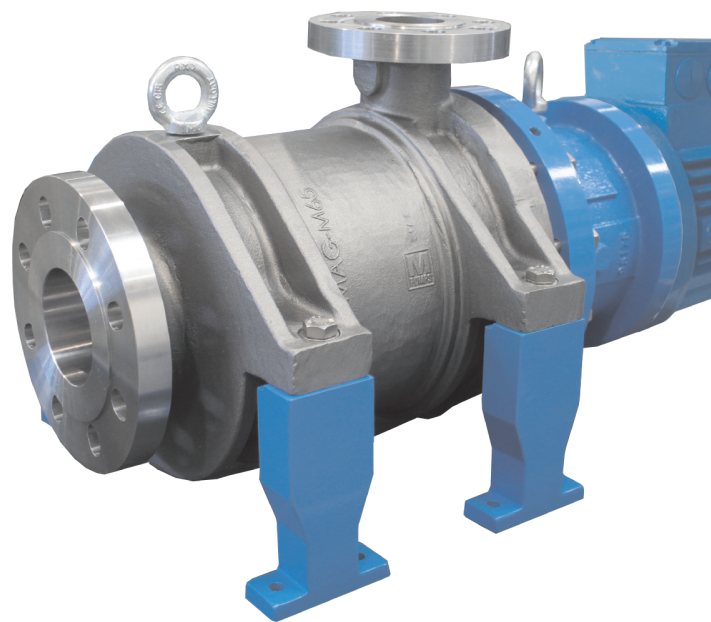

made for your process



Operating Range:

- Max viscosity 200cSt
- Max system pressure 50-100 BAR (std-depending on the congiguration)
- Flow up tp 75 m³/h
- Head up to 620m
- Temperature Range from -120 to +300°C (std)
- Electric motors from 0.5 to 250KW
- ATEX II - /2G cbk II C T5
- Parameters for information purposes , and not associated

SC MAG-M

**Regenerative side channel
Multistage Metallic Mag-Drive pumps**

*The widest side channel pump range on the market
Now with energy saving technology*

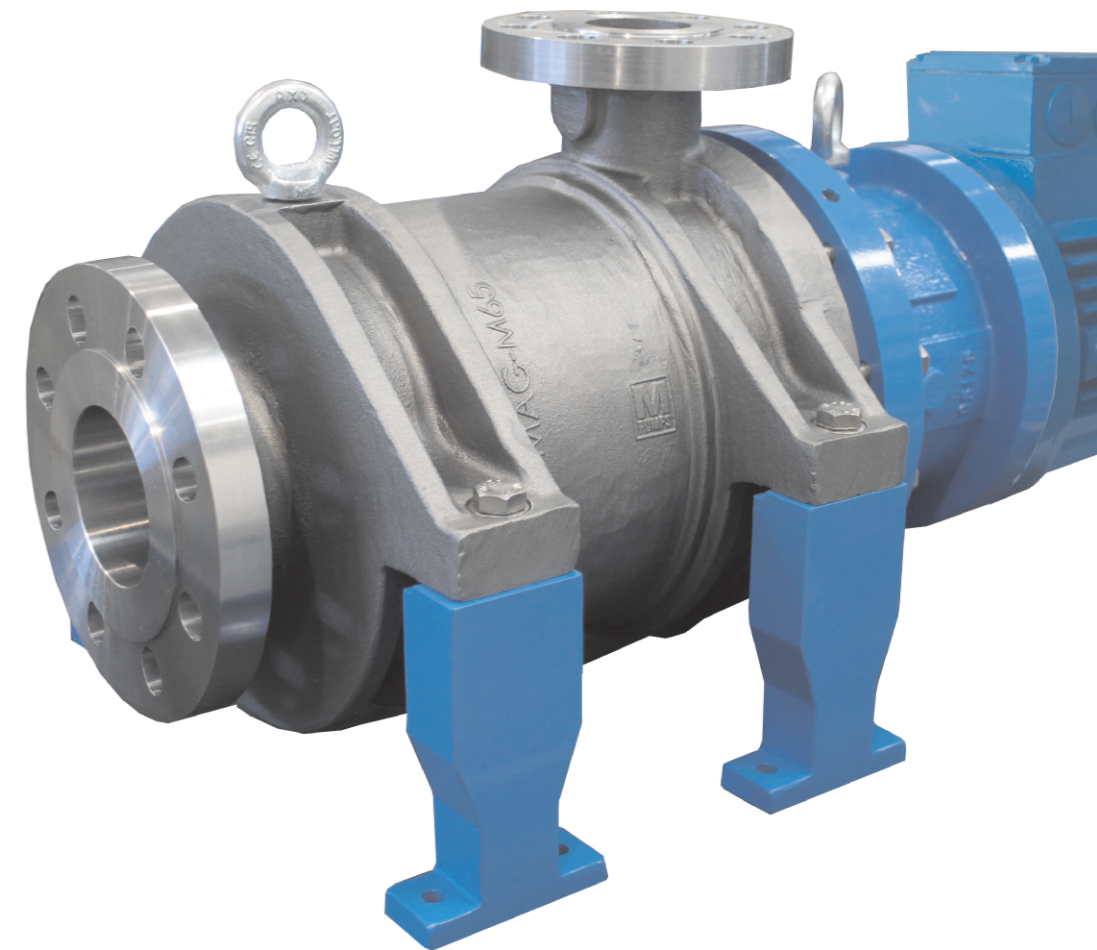

Application Fields:

- Fine Chemical Industry.
- Petrochemical Industry
- Semi-Conductor Industry
- Power Plant
- Pulp and Paper Industry
- Recycling Industry - Plating Industry
- Chemical Industry
- PCB Industry
- Waster Water Industry
- Pharmaceutical Industry
- Galvanizing Industry
- Plating Industry



Pump Details

Centerline Mounted Casing

Barrel construction with back inserted volute to improve hydraulic alignment and the wear rings life.

Particular design of the hydraulic, with self balancing impeller.

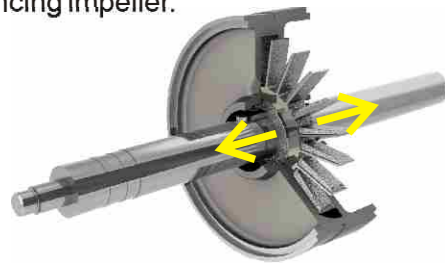

Stages number from 1 to 8

The range includes the construction from 1 to 8 stages, with inducer to minimize the required NPSH up to 0,5m, to allow the pumping of condensate and generally all low available NPSH installations.

Materials

CF8M pump casing, cover & Duplex 22%Cr impellers High quality casting components.

- Materials:
- Hastelloy®,
 - Incoloy®,
 - Duplex,
 - Others available on request.

Lubricated bearings

Field assembling of the product lubricated bearing arrangement does not require special tools. Available bearing materials in different types to provide the best solution for each application: Silicon Carbide (SSIC), Tungsten Carbide (TC), Metallized Carbon. The adoption of elastic rings reduces the sleeve bearing loads and the thrust bearing loads to the minimum, to guarantee many years of maintenance-free operation.



Nozzles

Suction and discharge connections are flanged CLASS 300-600 RF / PN 40-100, depending on stage number / system pressure. Other classes and facings on request.

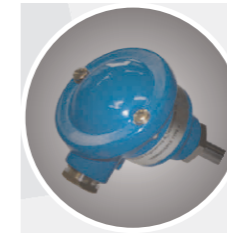
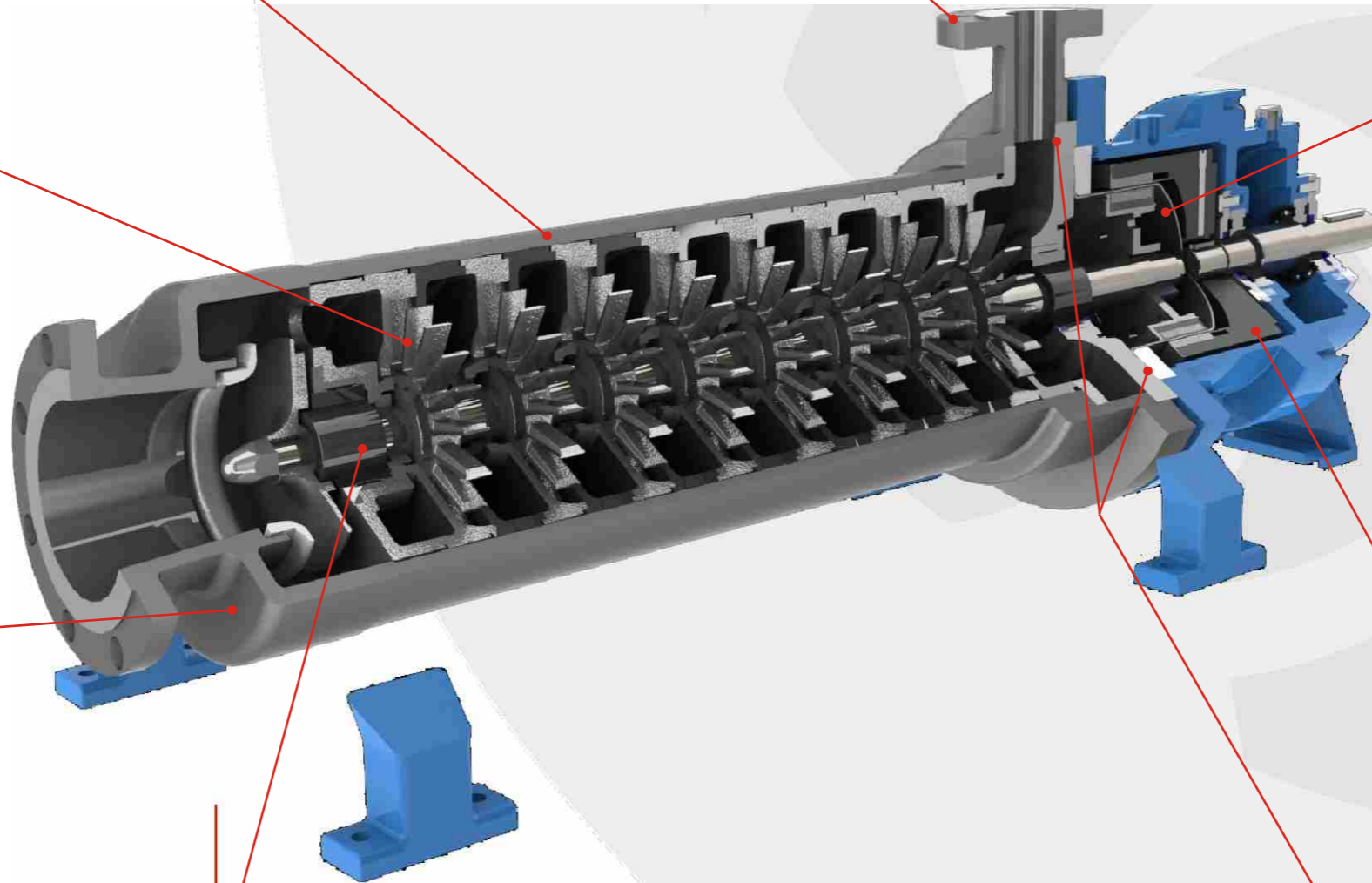

On demand:
integrated thermoprobe
sensor type E

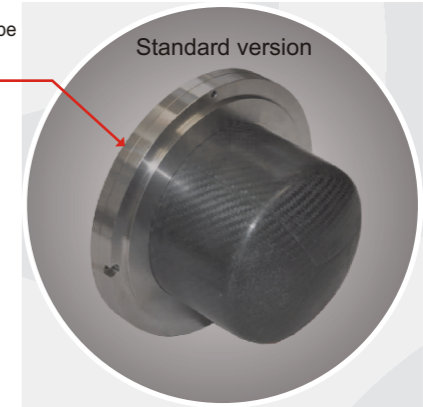

Standard version

The rear shell is made of one single piece, no welding, ellipsoidal profile that has been studied to withstand higher pressures than the traditional one.



Two versions available, Hastelloy®-C276 or Hybrid Containment shell. Higher pressure configuration can be supplied.

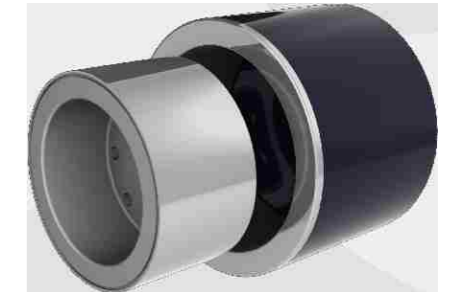

High power synchronous magnetic coupling designed by our technical office and with rare earth magnetic elements mechanically locked.

The high performance magnets can be operated at liquid temperatures of up to 572°F (300 °C) without external cooling.

Sealing system with flat gaskets prevents product from leaking to the atmosphere – different materials available:

- Asbestos free
- PTFE/R
- Graphoil
- Gylon®

Pump Performances

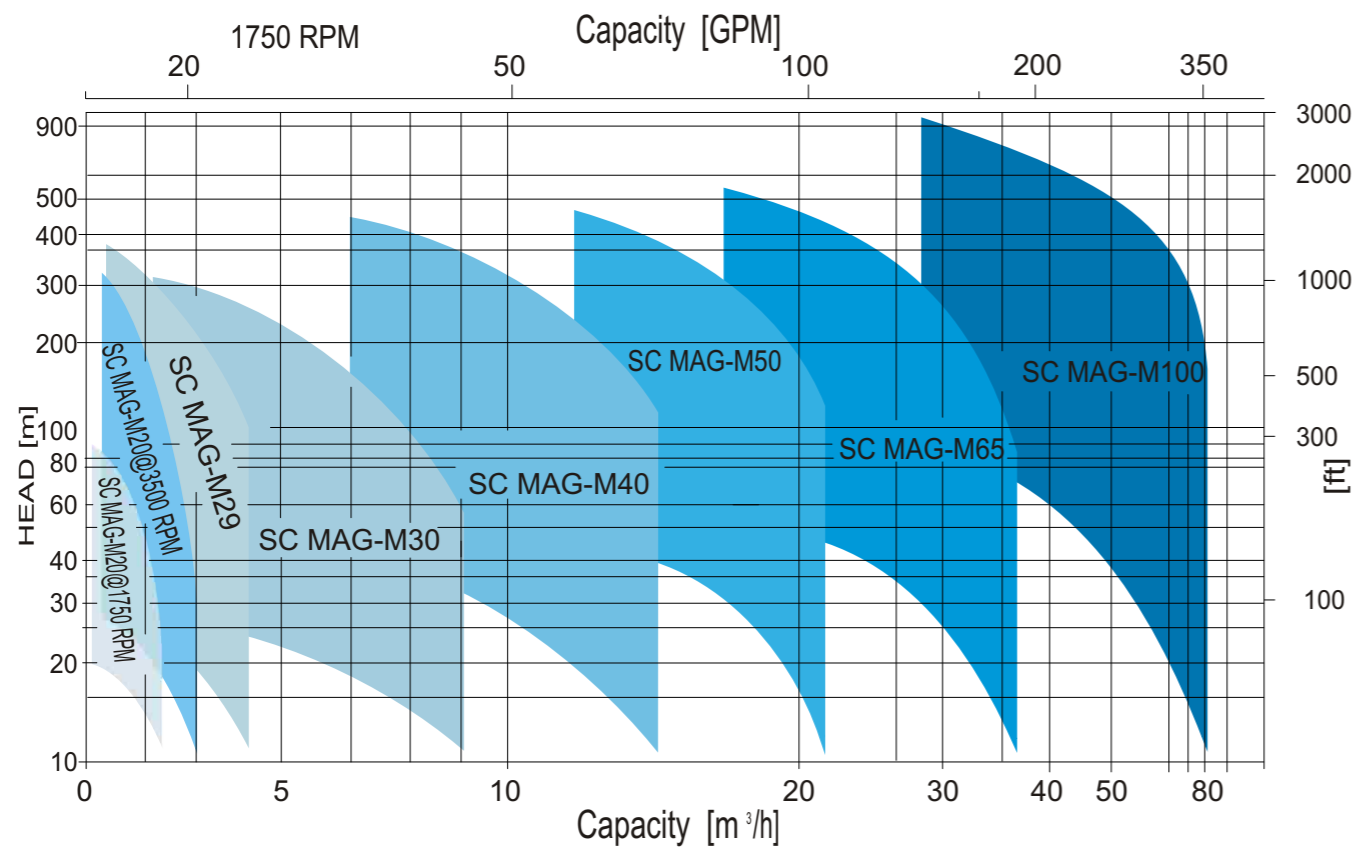
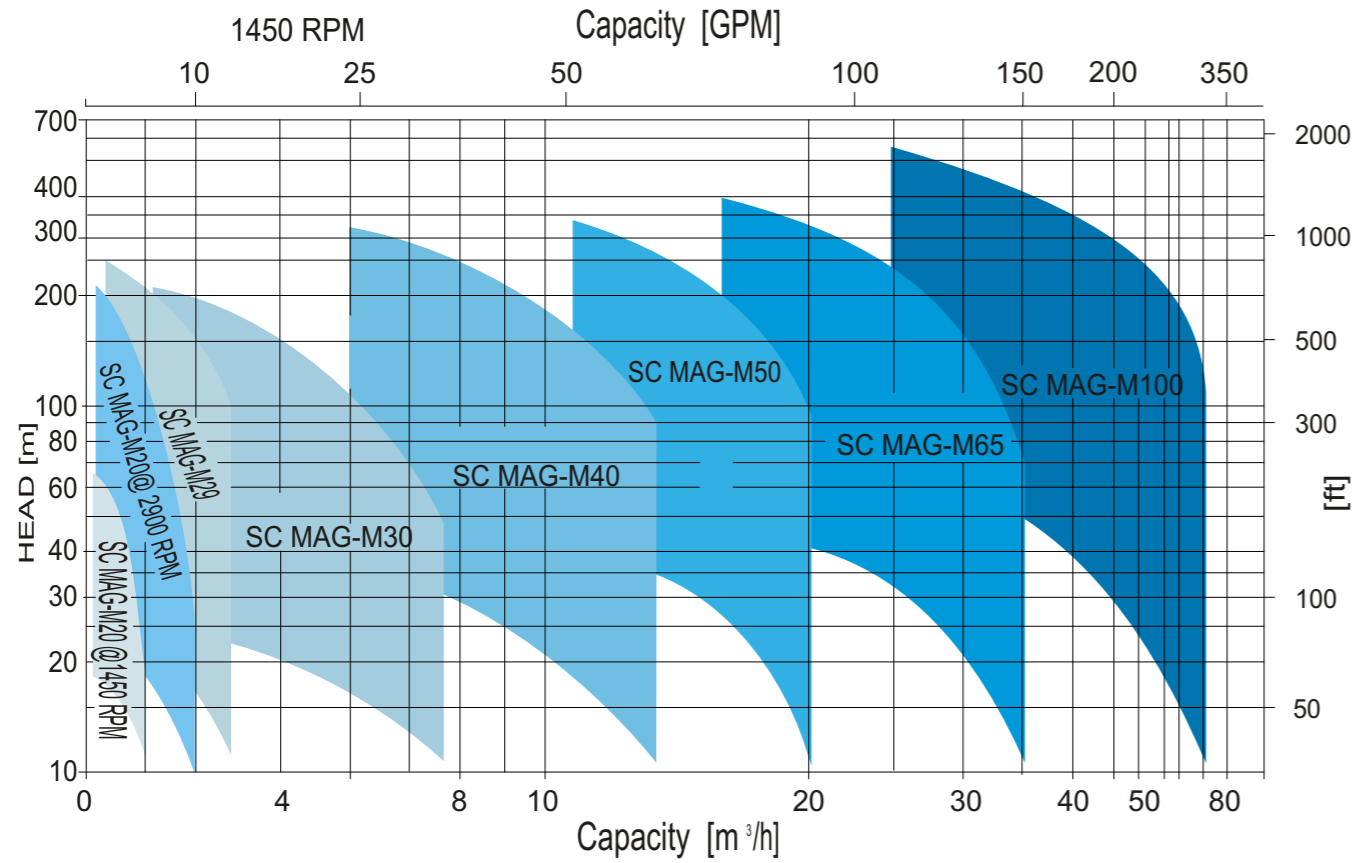

Successful Installations

SC MAG-M 30 / 2 stages, for pumping of WATER + CO₂ gas, Q=7 mc/h, H= 30m; Netherlands



SC MAG-M65 / 5 stages, for pumping of ISOBUTYLENE Q=35 mc/h, H= 40m; Ningbo - China.

SC MAG-M40 / 2 Stages for pumping of VINYL CHLORIDE in a chemical plant, Q=12 mc/h, H= 56m; Italy



Minimized Temperature rising on rear casing region

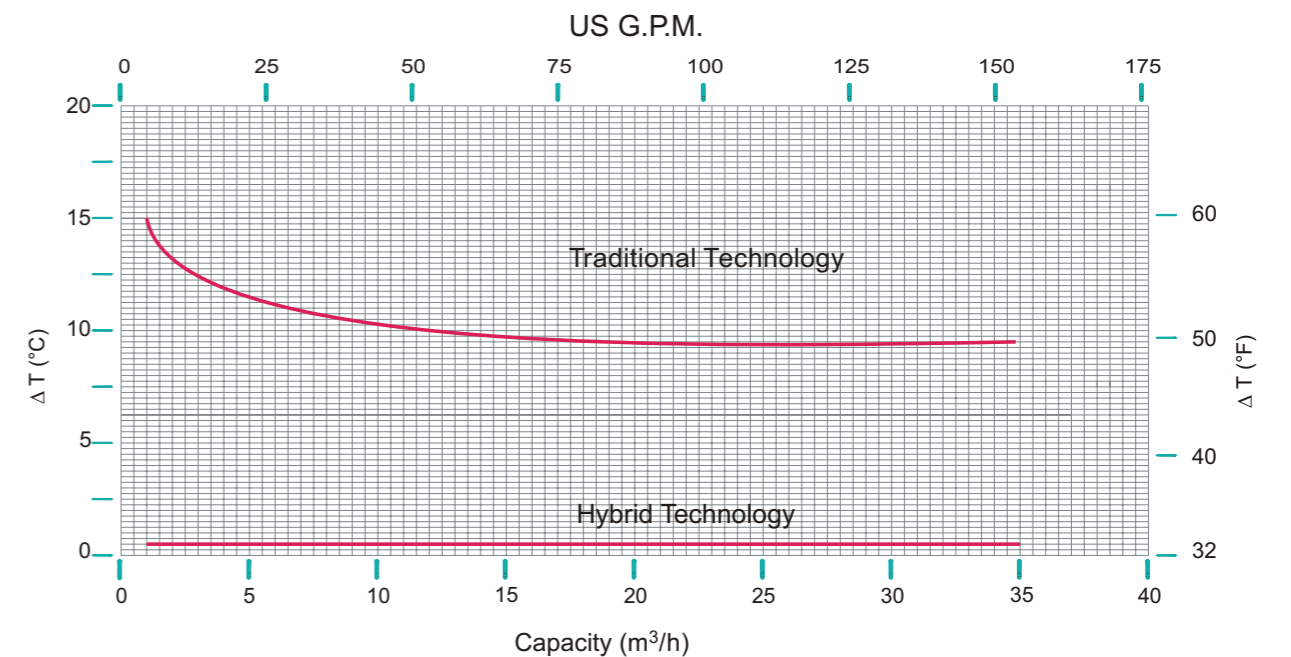

Hybrid technology reduces greatly heat generation in the rear casing region. This benefit is particularly important when pumping low boiling liquids.



Pump Configuration

SC MAG-M pump series are heavy duty side channel pumps, designed specifically for clean chemical process, low boiling and highly volatile, explosive and dangerous liquids.

This pump range puts a milestone on side channel pump history, as it is the first API design made.

That this pump range is not a common side channel pump range, is visible at a glance, as the pumps do not respect the outline imposed by EN 734.

Dimensions and working space around suction and discharge nozzles have been designed to allow the best condition for installation and maintenance.

A strong barrel construction has been adopted to increase operative safety in any condition, as these pumps are usually used in ATEX classified areas, for pumping dangerous and aggressive to the environment liquids.

Magnetic drive SC MAG-M pumps can be supplied in close couple version, even for high temperature versions, this configuration simplifies installation and eliminates alignment operation, and reduces footprint space requirements.

Applications

SC MAG-M pumps are side channel pumps with inducer for low NPSH requirements suitable to handle liquids which don't contain solids or abrasives. The NPSH inducer allows the operation under critical suction conditions, also at NPSHa as low as 0,5 m.

The particular design of the hydraulic allows to handle liquids close to boiling point has led to a wide field of application when condensate, distillate, coolant and liquefied gas shall be pumped.

SC MAG-M pumps are applied in the chemical and petrochemical industry, in the surface finishing and hardening, in the pharmaceutical industry, in the plastic and rubber industry, in the air conditioning and refrigeration engineering and in the food, beverage and tobacco industry.

FEATURES & BENEFITS

- Double centerline construction
- Extended temperature range
- Energy saving magnetic drive thanks to Hybrid containment shell
- Ability to pump liquid at boiling point
- Low NPSHr
- Possibility to pump with up to 50% gas
- Barrel Construction, for maximum safe, no gaskets and exposed segments
- Extra strong axial and radial bushing, spring monted
- Fully encapsulated magnets, no magnetic sectors exposed
- API 685 comply construction
- Heating / cooling jackets available
- Close couple or bare frame construction

Special Configurations

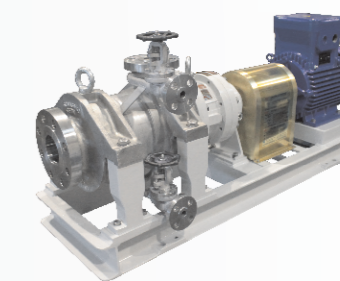
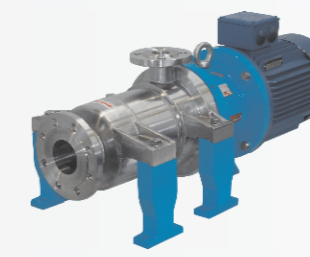
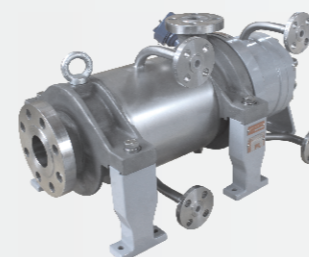

All pumps manufactured by M PUMPS are in full accordance to existing international standards

- ISO 9001-2013 certification ensures compliance to highest quality standards.
- ISO 14001-2004 certification proves M PUMPS absolute care for the environment.

Temperature influences on pump casing pressure resistance

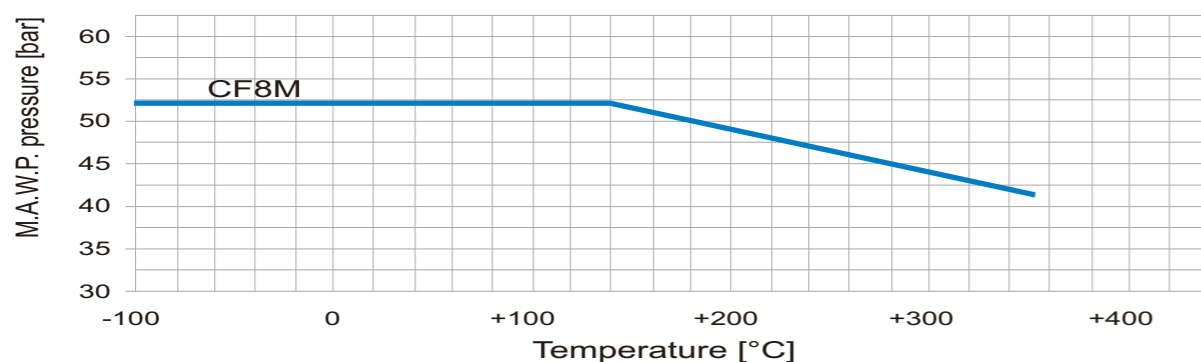

Protect your investment with Shaft Power Monitor

Technical data

- Supply voltage 100-240 VAC / 380-500 VAC / 525-690 VAC
- Frequency 50 Hz / 60 Hz
- Rated current Up to 999 A via current transformer
- Protection class IP20
- Approvals CE, UL, cUL



Smart protection for fixed speed application:

- Dry Running
- Cavitation
- Closed Valve
- Locked Pump Wheel
- Detect under load and overload
 - Flow variation
- Change of fluid density
- Activate alarm or shut down the pump before damage occurs.

The logo consists of the word "BEDU" in a large, bold, white sans-serif font, with "POMPEN" in a smaller, white sans-serif font below it. The text is centered within a dark teal square, which is itself centered within a white square border.

BEDU
POMPEN

made for your process

- Expert advice
- A customer-oriented organization that adapts to the requirements and wishes of your organization
- Innovative and customized solutions
- Breakdownservice, 24 hours a day, 7 days a week
- Technical service with extensive test facilities, working from our own workplace or at your location
- A fast and appropriate solution for all your issues
- Wide range of liquid pumps
- Repair, maintenance and revision

BEDU POMPEN B.V.
Poort van Midden Gelderland Rood 10
6666 LT HETEREN
Nederland
Telefoon +31 (0)88 4802 900
E-mail sales@bedu.eu

WWW.BEDU.NL

BEDU BELGIUM B.V.B.A.
Industriepark-West 75
9100 SINT-NIKLAAS
België
Telefoon +32 (0)3 80 87 980
E-mail sales@bedu.eu

WWW.BEDU.BE

