

MPS

Multi-Stage Submersible Clean Water Pumps

ARUBIX Company

PATENTED



Materials

Component	Material
Delivery casing External jacket Suction strainer Motor jacket	Chrome-nickel steel 1.4301 EN 10088 (AISI 304)
Stage casing Impeller	PPO-GF20 (Noryl)
Shaft	Chrome-nickel steel 1.4301 EN 10088 (AISI 304)
Capacitor cover Oil chamber cover Preload ring stages Support ring preload	PPS Polymer (Grivory)
Upper mechanical seal Lower mechanical seal	Steatite, carbon, NBR Carbon, silicon carbide, NBR
Seal lubrication oil	Oil for food machinery and pharmaceutical use

Construction

5" Close coupled multi-stage submersible pumps.
External jacket in stainless steel AISI 304 and stages Noryl.
 MPSM with built-in capacitor, accessible through the delivery casing.
 Hydraulics located below the motor with the motor cooled by the pumped fluid. Safe operation is possible with the motor only partially submerged.
 Double shaft seal with oil chamber.
 The suction strainer prevents the entrance of solids with diameter bigger than 2 mm.

Applications

For water supply from wells, tanks or reservoirs.
 For domestic, civil and industrial applications, for garden use, irrigation and rain water harvesting systems.

Operating conditions

Water temperature up to 35 °C.
 Minimum internal diameter of well: 140 mm.
 Minimum immersion depth: 100 mm.
 Maximum immersion depth: 20 m (with suitable cable length).
 Continuous duty.

Motor

2-pole induction motor, 50 Hz ($n \approx 2900$ 1/min).
MPS : three-phase 230 V \pm 10%;
 three-phase 400 V \pm 10%.
 Cable: H07RN8-F, length 15 m, without plug.
MPSM : single-phase 230 V \pm 10%, with thermal protector.
 Incorporated capacitor.
 Float switch MPSM.. CG (on demand)
 Cable: H07RN8-F, length 15 m, with plug CEI-UNEL 47166.

Insulation class F.
 Protection IP X8 (for continuous immersion).
 Triple impregnation humidity-proof dry winding.
 Constructed in accordance with EN 60335-2-41.

Special features on request

- Other voltages.
- Frequency 60 Hz (as per 60 Hz data sheet).
- Cable length 20 m.
- Motor suitable operation with frequency converter.

Coverage chart $n \approx 2900$ rpm

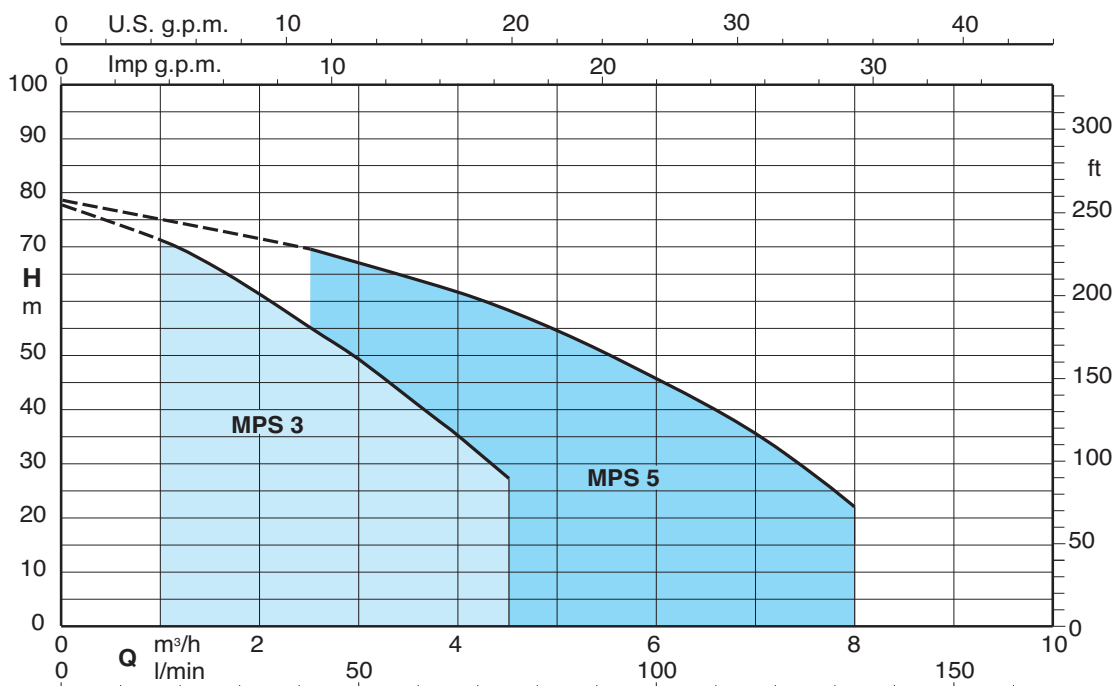

Performance n ≈ 2900 rpm

3~	230 V 400 V		1~	230 V		Capacitor		P ₁		P ₂		Q	H m								
	A	A		A	μF	V	kW	kW	HP	m ³ /h	0		1	1,5	2	2,5	3	3,5	4	4,5	
MPS 303	2,4	1,4	MPSM 303	3,5	14	450	0,8	0,45	0,6	H m	0	16,6	25	33,3	41,6	50	58,3	66,6	75		
MPS 304	2,8	1,6	MPSM 304	4,1	20	450	0,9	0,55	0,75		0	16,6	25	33,3	41,6	50	58,3	66,6	75		
MPS 305	3,3	1,9	MPSM 305	5	20	450	1,1	0,75	1		32,5	29,5	27,5	25,5	23	19,5	17	13	10		
MPS 306	3,8	2,2	MPSM 306	6	25	450	1,3	0,9	1,2		44	41,5	39,5	36,5	33,5	29,5	25,5	21	16		
MPS 307	4,5	2,6	MPSM 307	6,6	25	450	1,5	0,9	1,2		54	49,5	46,2	43	39,9	35	30	25	19		
											66,5	60,5	57	53	48,5	43,5	38	32	26		
										75	67,5	63	58	53	47	41	34,5	27			

3~	230 V 400 V		1~	230 V		Capacitor		P ₁		P ₂		Q	H m								
	A	A		A	μF	V	kW	kW	HP	m ³ /h	0		2,5	3	3,5	4	4,5	5	6	7	8
MPS 503	2,8	1,6	MPSM 503	4,1	20	450	0,9	0,55	0,75	H m	0	41,6	50	58,3	66,6	75	83,3	100	116	133	
MPS 504	3,8	2,2	MPSM 504	6	25	450	1,2	0,9	1,2		0	41,6	50	58,3	66,6	75	83,3	100	116	133	
MPS 505	4,5	2,6	MPSM 505	7	25	450	1,5	1,1	1,5		32,2	28,5	27,5	26	24,5	22,5	21,5	18	13,5	8	
MPS 506	4,8	2,8	MPSM 506	8,3	30	450	1,7	1,1	1,5		45	39,5	37,8	35,8	33,5	31	28,5	23	16,5	9,5	
MPS 507	6,9	4	MPSM 507	12	35	450	2,2	1,5	2		53	47,5	45,5	43,5	41	38,5	35,5	29,5	22	13,5	
											66,5	58	55,6	53	50	46,3	42,5	34	24,5	14	
										78,5	69,5	66,5	64	61,5	58	54,5	45,5	36	22		

P₁ Max. power input. P₂ Rated motor power output. Tolerances according to UNI EN ISO 9906:2012 Test results with clean cold water, without gas content.

Dimensions and weights

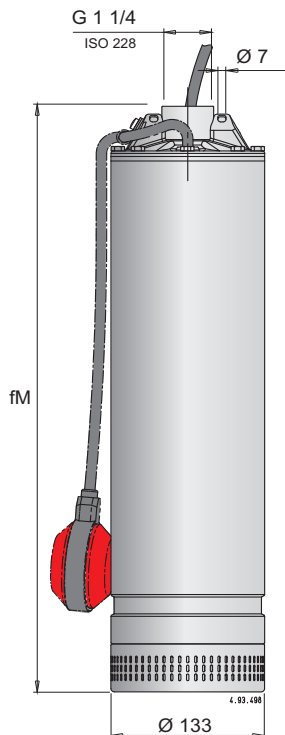

MPSM ... CG

With float switch pump (on demand)

Weights with cable length: 15 m

Pump	fM mm	kg		Cable H07RN8-F		
		MPS	MPSM	230V 1~	230V 3~	400V 3~
MPS 303 - MPSM 303	465	11	12	3G1 mm ²	4G1 mm ²	4G1 mm ²
MPS 304 - MPSM 304	504	11,5	12,5	3G1 mm ²	4G1 mm ²	4G1 mm ²
MPS 305 - MPSM 305	553	12	13	3G1 mm ²	4G1 mm ²	4G1 mm ²
MPS 306 - MPSM 306	577	13,5	15	3G1 mm ²	4G1 mm ²	4G1 mm ²
MPS 307 - MPSM 307	601	14	15,5	3G1 mm ²	4G1 mm ²	4G1 mm ²
MPS 503 - MPSM 503	480	11,5	12,5	3G1 mm ²	4G1 mm ²	4G1 mm ²
MPS 504 - MPSM 504	529	13,5	14,5	3G1 mm ²	4G1 mm ²	4G1 mm ²
MPS 505 - MPSM 505	553	14	15	3G1 mm ²	4G1 mm ²	4G1 mm ²
MPS 506 - MPSM 506	622	15,5	17	3G1,5 mm ²	4G1 mm ²	4G1 mm ²
MPS 507 - MPSM 507	671	17	18,5	3G2,5 mm ²	4G1 mm ²	4G1 mm ²

Characteristic curves $n \approx 2900$ rpm

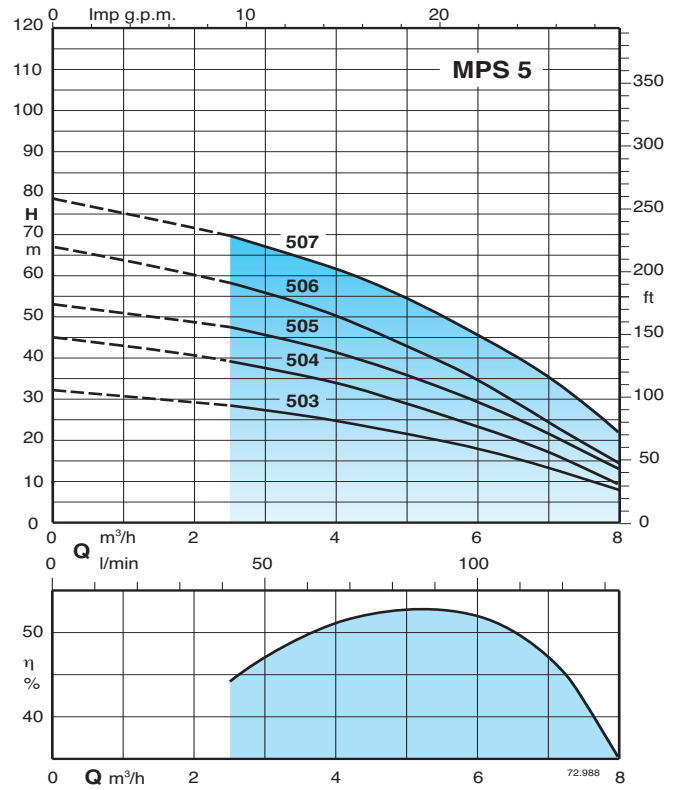
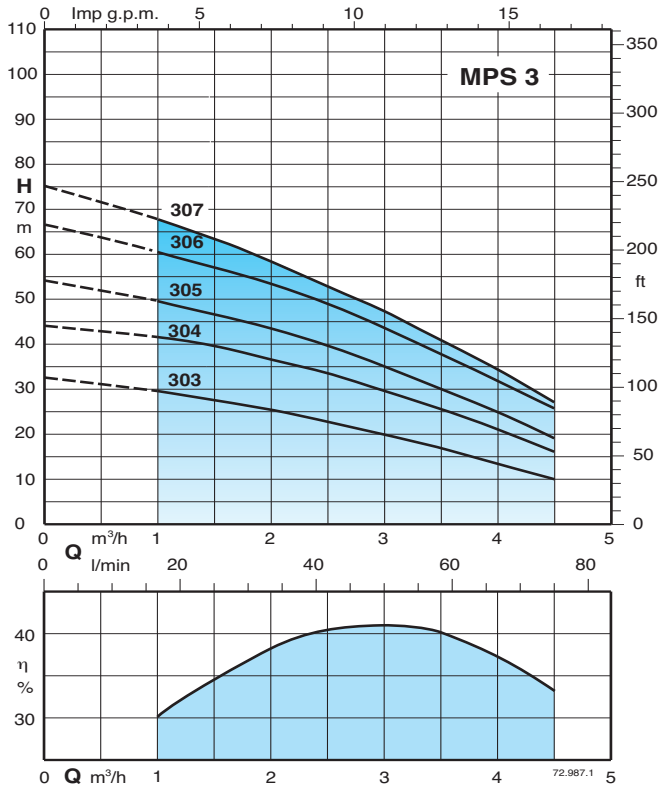

Features

Innovative

Designed to withstand water hammering and the ON-OFF operation of any valve located in the discharge line.

The impacts generated by water hammering or by the closing of the valve are fully supported by the capacitor cover, which relieves the stresses on a specific support made on the stainless steel jacket, without affecting the plastic hydraulic part.

Flexible

Allows the inspection of the capacitor without disassembling the pump, through the delivery casing.

Reliable

The ball bearings and shaft are sized in order to reduce stresses, guaranteeing high reliability in any operating condition.

Low cost installation

Immersed, without suction pipe and valves. The cylindrical suction strainer provides support for the pump when installed on a flat surface or tank bottom. For operation with 100 mm minimum water level.

PATENTED

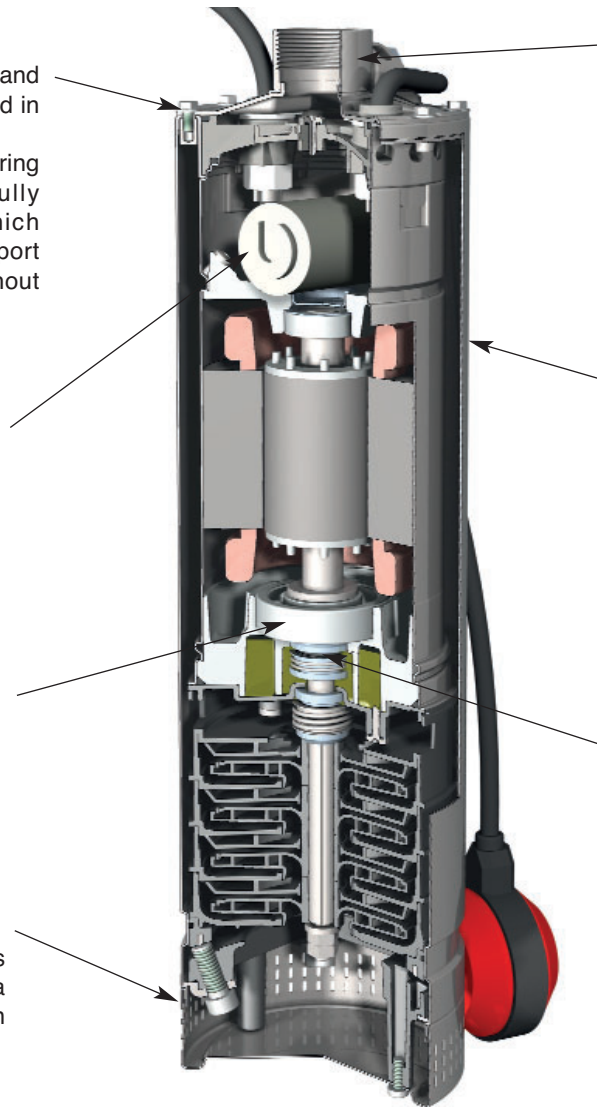

Robust

Its robust stainless steel external construction allows for the pump to be suspended from the delivery pipe.

Low-Noise operation

The design of hydraulic parts, the water-filled shroud around the motor and the submerged operation ensures low noise operation.

Greater Safety

The double shaft sealing with an oil chamber separates the motor from the water and provides further protection against accidental operation when dry.

Installation

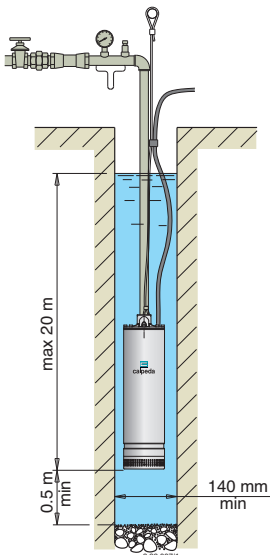

Pump in suspended position

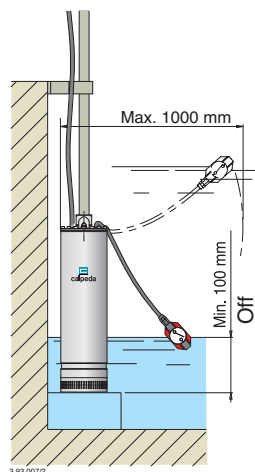

Pump with float switch (on demand)

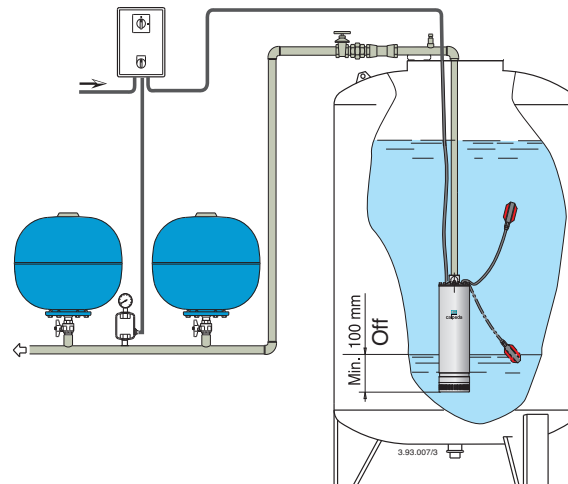

Installation example